

IC-781: Installing the Inrad Roofing Filter Mod

The Icom IC-781 roofing filter mod consists of a 6-pole, 4 to 5 kHz wide filter followed by a high dynamic range, feedback amplifier. The amplifier provides enough gain to override the filter insertion loss.

The following plot shows the sweep frequency response of the front end and first IF filter in a IC-781 radio. The wider curve is the OEM response and the narrow curve is with the Inrad roofing filter mod added.

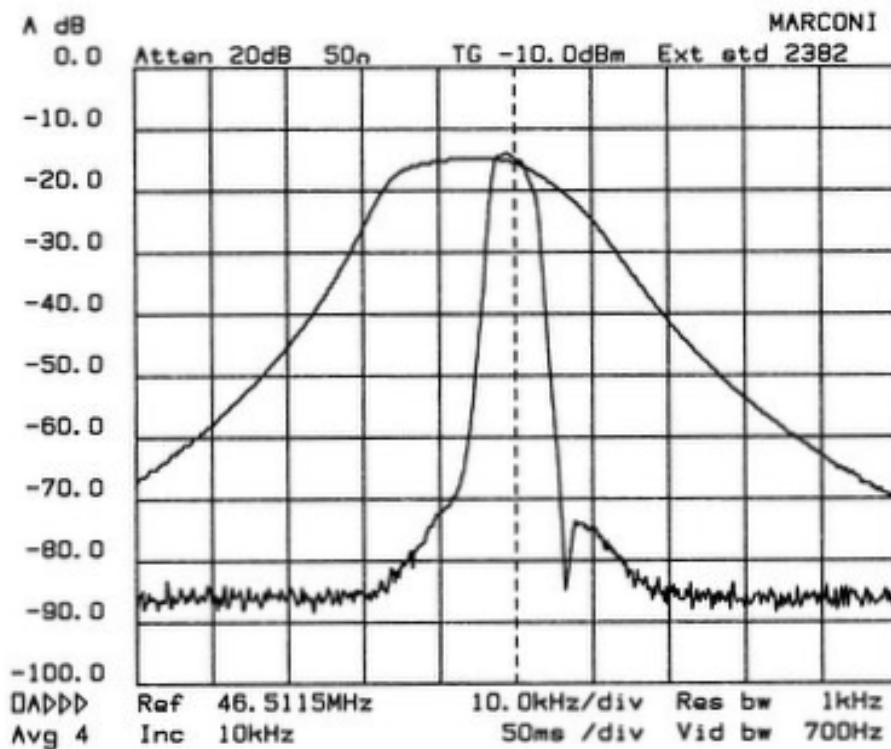

Figure 1

The result of the bandwidth improvement shown above is the reduction of close in intermodulation from multiple signals. The IMD dynamic range will be improved 7 to 14 dB for some signal spacings. The main receiver audio response will be reduced about 100 Hz in the SSB mode. Operating the noise blanker will not result in as much degradation of the dynamic range.

Frequently Asked Questions

1. What can you expect from this mod?

Less IMD in crowded band conditions, particularly from stations at offset frequencies of 2 to 20 kHz on either side of the operating frequency.

2. Will it defeat the noise blanker?

No, the roofing filter is in the circuit before the noise blanker sample is taken. The filter delay is added to both signal and noise. Since less noise and fewer strong signals are able to reach the noise blanker, it actually improves its operation.

3. Will this mod allow for wide band SSB, AM and FM reception?

The overall widest bandwidth of the receiver will be determined by the roofing filter, which is about 5 kHz. AM and FM will be degraded, but not excessively. Normal 2400 Hz SSB will not be affected.

Description of Operation

The Roofing filter mod inserts a narrow band crystal filter in between the pin attenuator following the first mixer and the grounded gate first IF amplifier. An amplifier is included to compensate for the filter loss. Reducing the bandwidth at this point in the radio helps to keep strong off-frequency signals out of the second mixer where they can cause intermodulation. Transmission is not changed as it does not pass through the roofing filter.

Installation Instructions

Warning: *Modern radios contain components which may be damaged by static discharge. Precautions must be taken to eliminate any static electricity buildup between the operator and the radio before any of the internal circuits are touched. If you are not familiar with the proper techniques for this, consult the Radio Amateurs Handbook.*

Note: If you have a known test signal available before you start, note the S meter reading. The marker generator can be used at 7050 kHz. After the installation, the S meter should read the same or slightly higher than before for the A side of the receiver and the same as before for the B side.

1. Prepare one side of each coax cable to accept a TMP connector by stripping about ½ inch of outer covering and shield. Strip about 1/4 inch of insulation from the center conductor. Insert the center conductor into the TMP connector center pin and solder it in. Then take the dressed braid and solder it to the connector outer shield. See Figure 2 for more information on the cable preparation.
2. Remove the AC line cord from the transceiver.
3. Remove the top cover. Disconnect the speaker wire. Remove the shield cover on the RF board.
4. Remove the Inrad roofing filter mod from its packing. Insert the four mounting posts into the four corner holes in the Inrad PC board.
5. Strip 1/8" from each end of the red and black wires.
6. Connect the red wire to TB1 marked +18V on the Inrad board.
7. Connect the black wire to the terminal marked Gnd. Install the mod board as shown in Figure 3. Dress the wires out of the way for now.
8. Disconnect the coax cables and other connectors from the RF board. There are 7 coax cables and 7 multi-pin cables.
9. Remove the 5 screws holding the RF board in place. Remove the RF board.
10. Remove wire W23 as seen in Figure 4.

11. Insert the center wire conductor of one of the coax cables into a hole left from W23. Solder.
12. Insert the center wire conductor of the other coax cable into the second hole left from W23. Solder.
13. Solder the shields of both coax cables to the side of the shield can as shown in Figure 5.
14. Replace the RF board.
15. Dress the coax cables through the slot in the RF board shield and over to the Inrad mod. The coax connected to the W23 hole nearest the front panel should be plugged into J1 of the Inrad mod.
16. The coax connected to the W23 hole nearest the rear panel should be plugged into J2 of the Inrad mod.
17. Solder the red wire to the point (at L137) on the RF board shown in Figure 6.
18. Solder the black wire to the ground point (ground wire) shown in Figure 6.
19. Replace the shield cover on the RF board.
20. Replace the power cord and turn the radio on. Verify that both the A side and the B side are working before final assembly.
21. Replace the speaker wire and the radio top cover.

This completes the installation.

Figure 2 - TMP Connector Installation

Prepare one end of each coax cable to accept a TMP connector as shown.

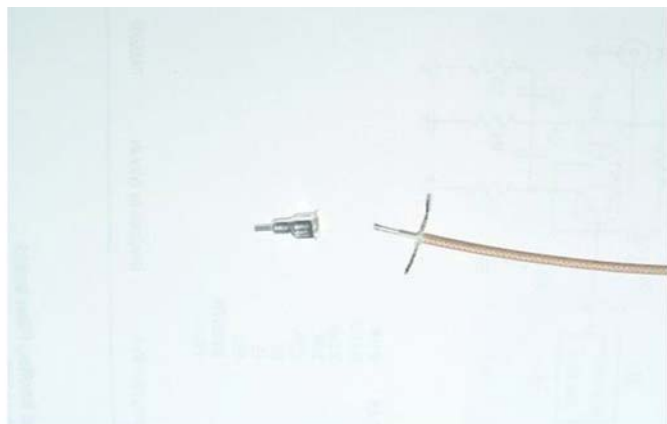

Figure 3 – Mod Location

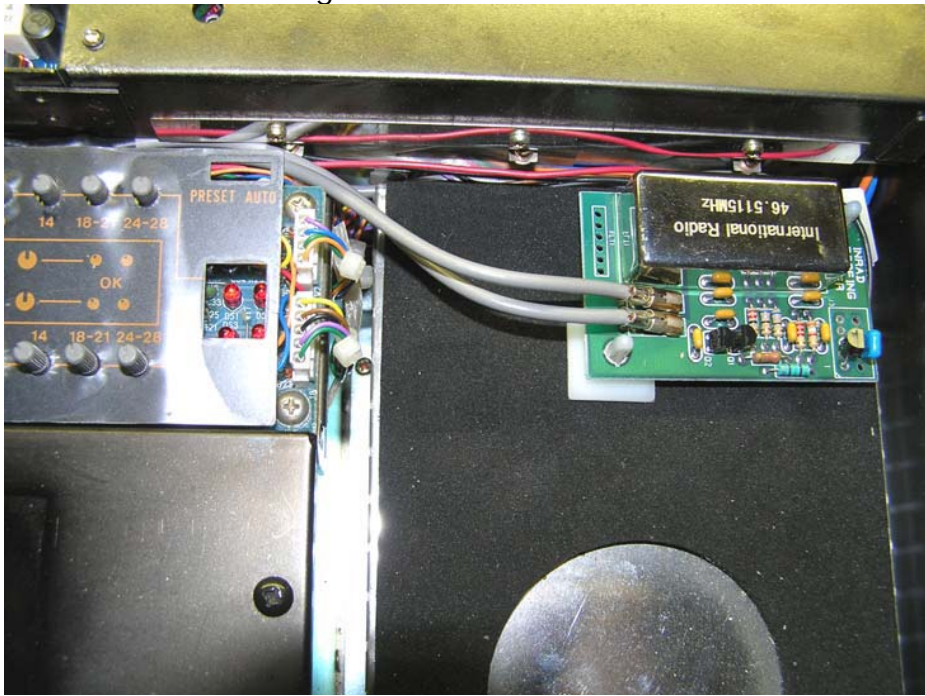

Figure 4 – W23 Location

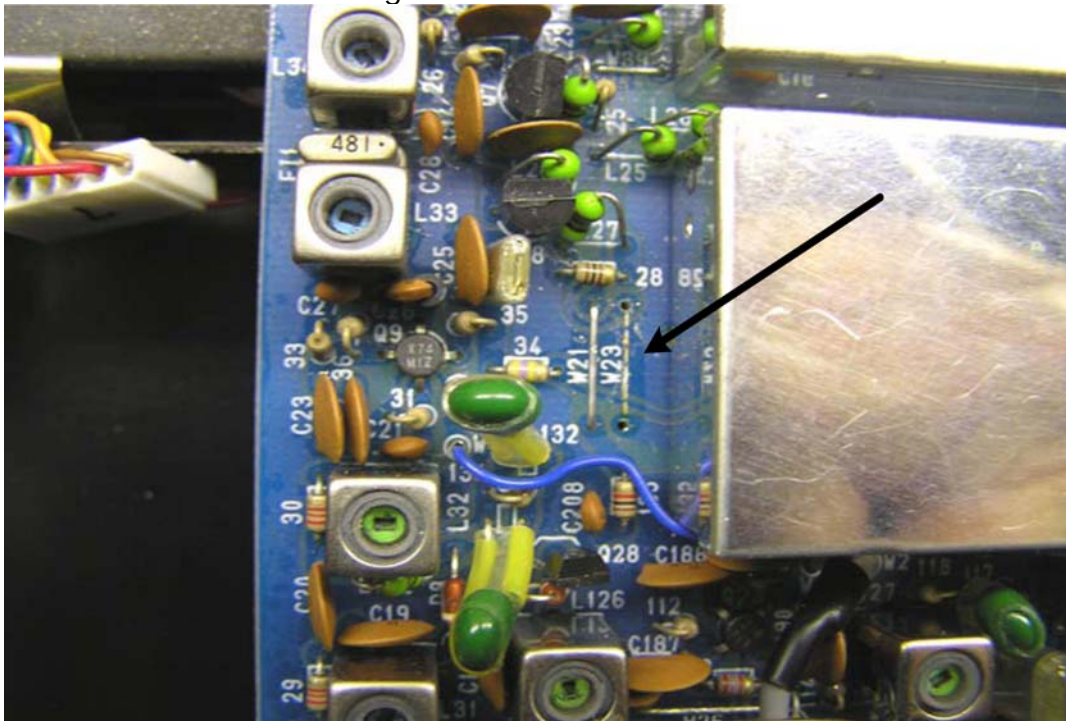

Figure 5 – Coaxial Shield Solder Location

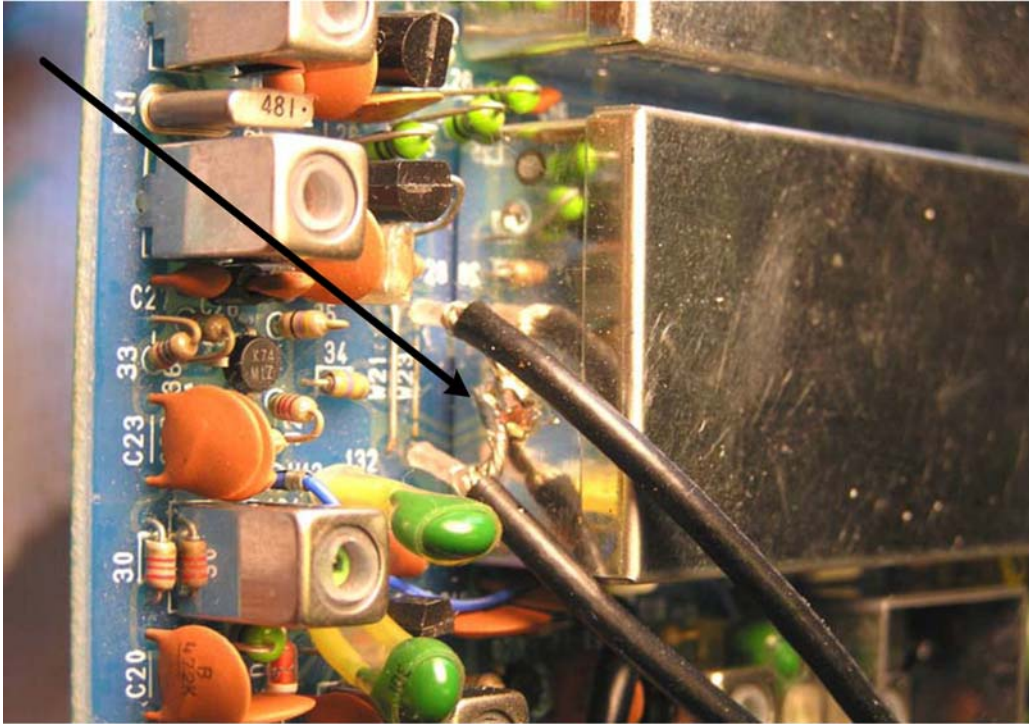

Figure 6 – DC Wire Locations

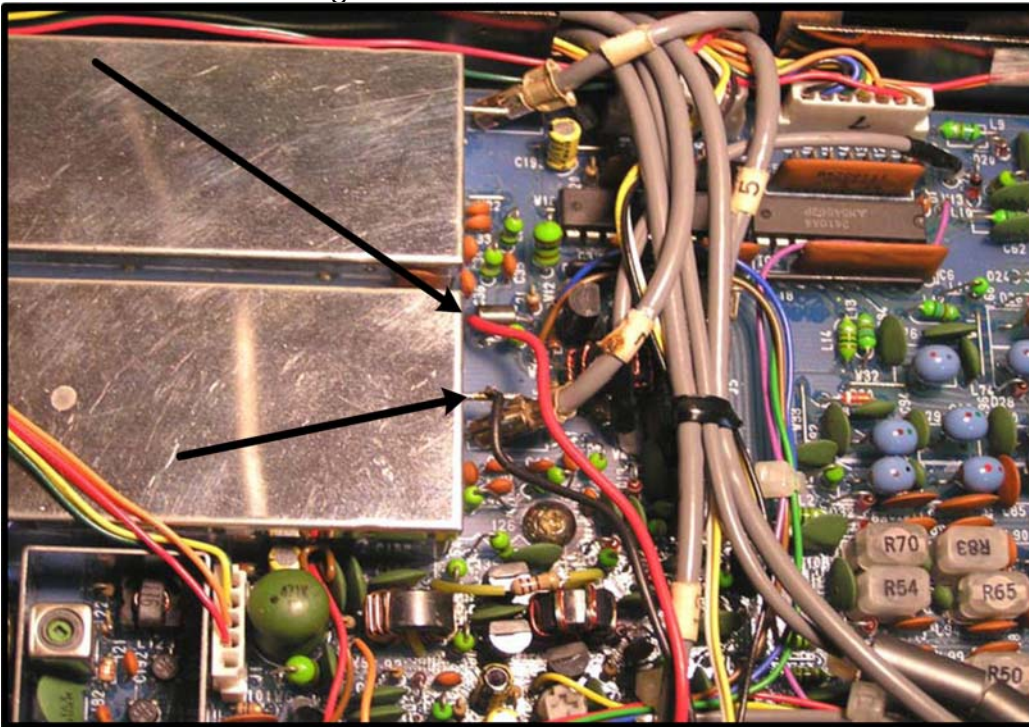
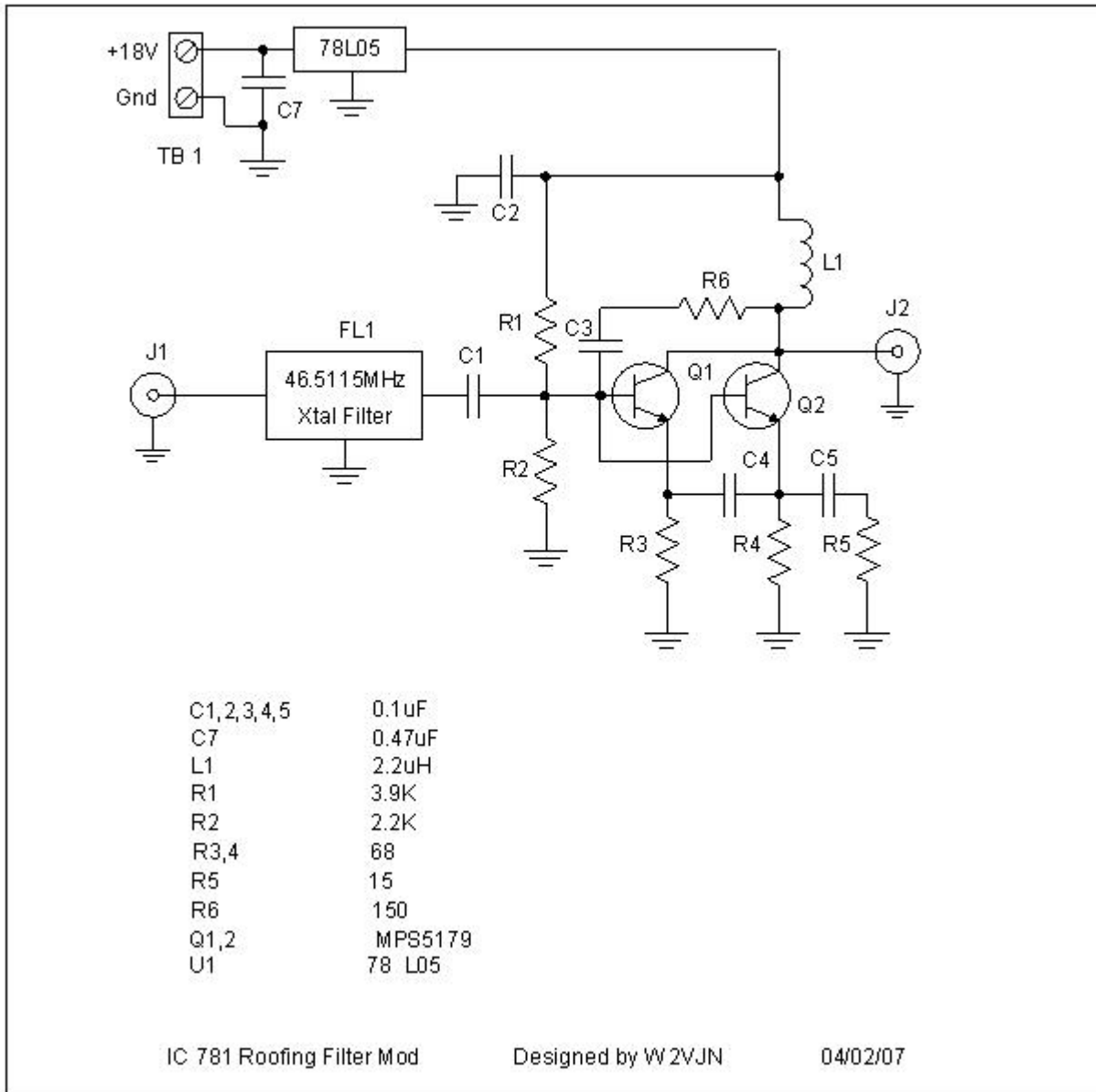

Figure 7 – Schematic and Parts List



Parts List

- Assembled Roofing Filter board (Inrad #120)
- 2 Coax cables 18"
- 2 male TMP connectors
- 4 Board mounts with nuts
- 24" #22 insulated solid wire (red)
- 24" #22 insulated solid wire (black)